



Autocar
DISTRIBUTIONS

COMPOSIZIONE TETTI REGOLABILI PER / ADJUSTABLE ROOF SYSTEM
ASSEMBLY FOR / VERDECKBESTANDTEILE FÜR "FIX"

Anno / Year / Jahr **2022**

Tetto / Roof / Verdeck "FIX"



Pagine / Pages / Seiten 20-21



Pagina / Page / Seite 11

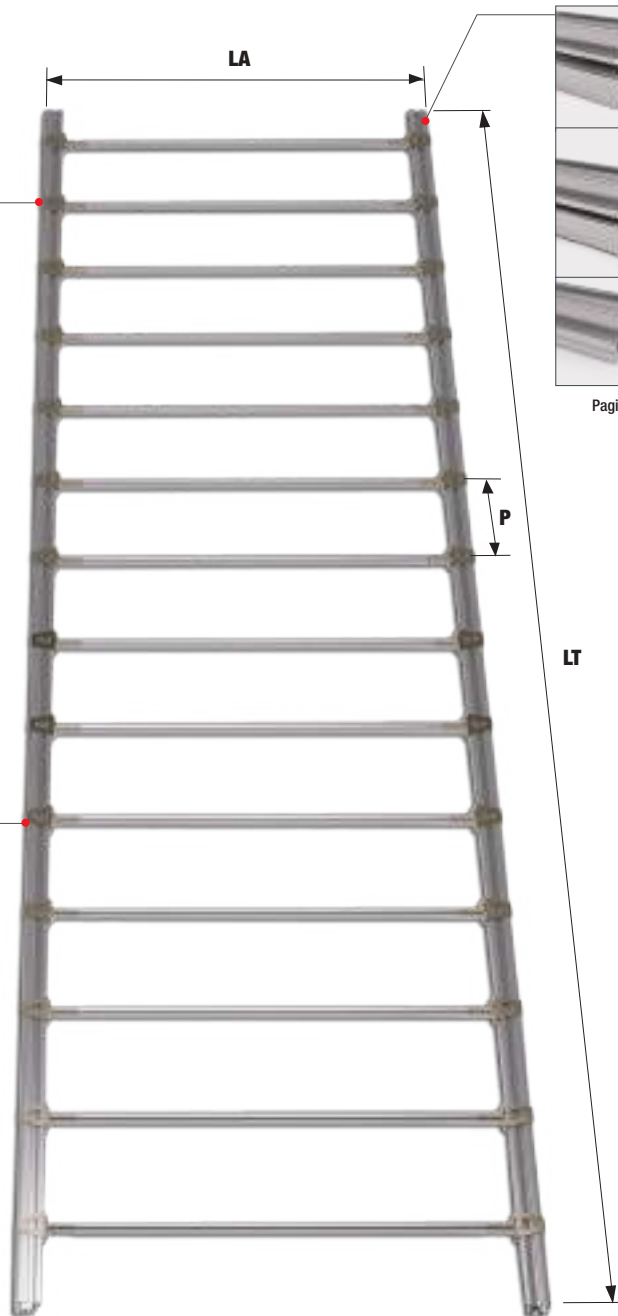

Pagine / Pages / Seiten 23-24

P = max. 550 mm

LA = da / from / von 2000 mm a / to / bis 2600 mm

LT = da / from / von 3000 mm a / to / bis 13700 mm

Tabella composizione tetto regolabile / Adjustable roof assembly table / Bestandteiltabelle verstellbares Schiebeverdeck "FIX"

LUNGHEZZA TETTO ROOF LENGTH VERDECKLÄNGE (mm)		FIX4 LARGHEZZA ARCO CENTRALE CENTRAL CROSSBEAM WIDTH SPRIEGELBREITE da / from / von (mm) - a / to / bis (mm)					FIX5 ARCO CENTINATO da 2481 a 2600 mm CAMBERED CROSSBEAM from 2481 to 2600 mm SPRIEGEL GEWÖLBT von 2481 bis 2600 mm
		2000	2121	2241	2361	2481	
		2120	2240	2360	2480	2600	
Codice / Code no. / Art.Nr.		5.8042	5.8043	5.8044	5.8045	5.8046	5.8040
da / from / von	a / to / bis	q.tà archi / qty. crossbeam / Menge Spriegel					q.tà / qty. / Menge
2750	3300	5					5
3301	3850	6					6
3851	4400	7					7
4401	4950	8					8
4951	5500	9					9
5501	6050	10					10
6051	6600	11					11
6601	7150	12					12
7151	7700	13					13
7701	8250	14					14
8251	8800	15					15
8801	9350	16					16
9351	9900	17					17
9901	10450	18					18
10451	11000	19					19
11001	11550	20					20
11551	12100	21					21
12101	12650	22					22
12651	13200	23					23
13201	13700	24					24

Tabella quantità consigliate per piantoni e carrellini tenda / Table with suggested quantities for pillars and curtain rollers / Tabelle mit Angabe der vorgeschlagenen Mengen für Rungen und Planenroller

LUNGHEZZA / LENGTH / LÄNGE		Carrelli piantone / Pillar holders / Rungenlaufwagen	Carrellini tenda / Curtain rollers Planenroller
da / from / von	a / to / bis	q.tà / qty. / Menge	q.tà / qty. / Menge
2750	4000	0	16
4001	4600	0	20
4601	5500	2	24
5501	6600	2	28
6601	7500	2/4	32
7501	8500	4	36
8501	10000	4	44
10001	13700	6	48

Arco diritto / Straight crossbeam / Spriegel gerade "FIX 4"

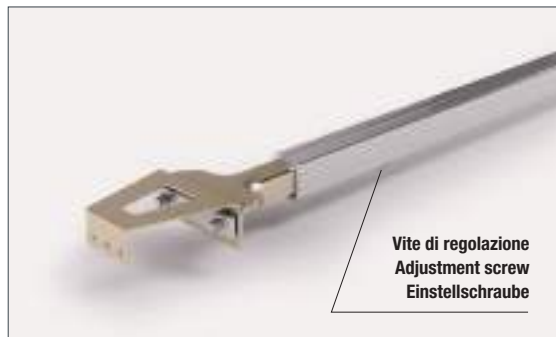
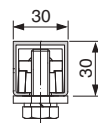
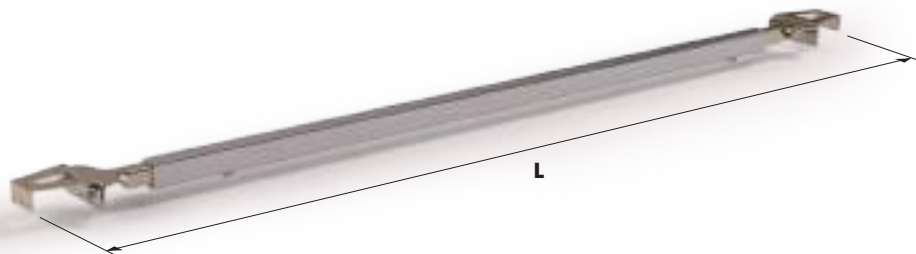

Codice / Code no. Art.Nr.	L= Larghezza regolabile / Adjustable width Verstellbare Breite	Peso / Weight / Gewicht Kg
5.8042	Da 2000 a 2120 mm / From 2000 to 2120 mm / Von 2000 bis 2120 mm	4,2
5.8043	Da 2121 a 2240 mm / From 2121 to 2240 mm / Von 2121 bis 2240 mm	4,3
5.8044	Da 2241 a 2360 mm / From 2241 to 2360 mm / Von 2241 bis 2360 mm	4,4
5.8045	Da 2361 a 2480 mm / From 2361 to 2480 mm / Von 2361 bis 2480 mm	4,5
5.8046	Da 2481 a 2600 mm / From 2481 to 2600 mm / Von 2481 bis 2600 mm	4,6

Arco centinato / Cambered crossbeam / Spriegel gewölbt "FIX 5"

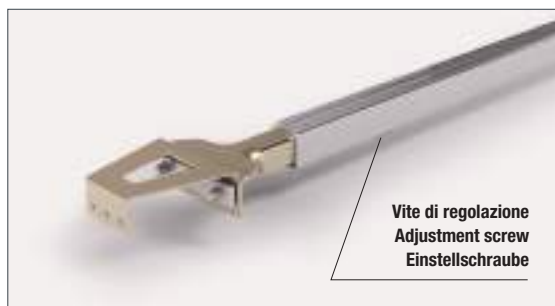
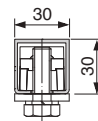
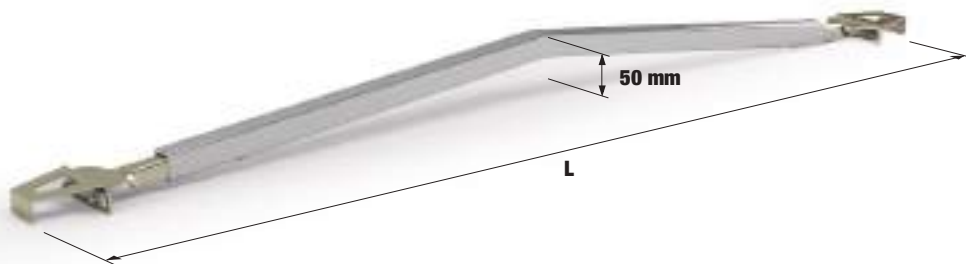

Codice / Code no. Art.Nr.	L= Larghezza regolabile / Adjustable width Verstellbare Breite	Peso / Weight / Gewicht Kg
5.8040	Da 2481 a 2600 mm / From 2481 to 2600 mm / Von 2481 bis 2600 mm	5

Kit estremità arco FIX 5 centinato / FIX 5 cambered crossbeam end kit / Kit Spriegel Laufwagen FIX 5-gewölbt

Codice Code no. Art.Nr.	Applicabile a: Fits to: Passend zu:	Peso / Weight Gewicht Kg
5.8039	Arco centinato FIX 5 FIX 5 cambered crossbeam FIX 5 Spriegel gewölbt	0,5

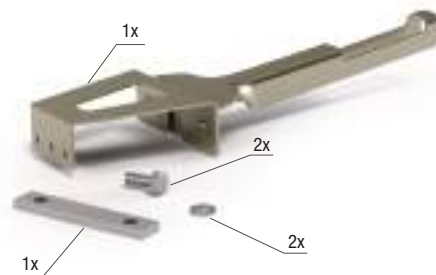

Kit estremità arco FIX 4 diritto / FIX 4 straight crossbeam end kit / Kit Spriegel Laufwagen FIX 4-gerade

Codice Code no. Art.Nr.	Applicabile a: Fits to: Passend zu:	Peso / Weight Gewicht Kg
5.8038	Arco diritto FIX 4 FIX 4 - straight crossbeam Spriegel gerade FIX 4	0,5

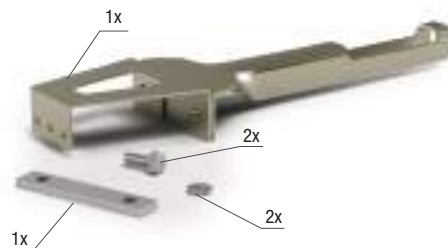

Kit fissaggio arco centrale FIX / FIX central crossbeam fixing kit / FIX Spriegelbefestigungskit

Codice Code no. Art.Nr.	Descrizione Description Beschreibung	Peso / Weight Gewicht Kg
5.3378	Kit fissaggio Fixing kit Befestigungskit	0,2

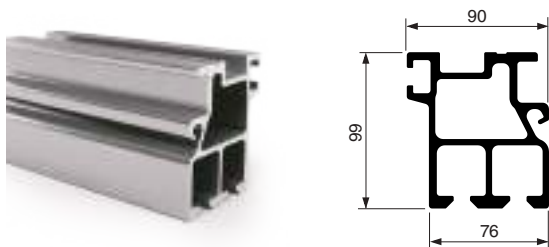

Guide / Beams / Dachgurtprofile "STANDARD"

6,3 Kg/m

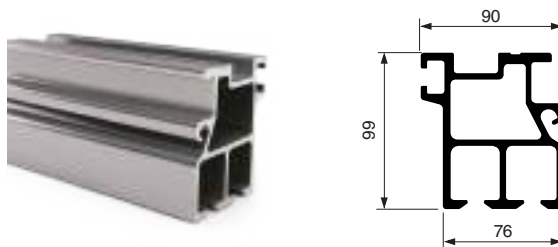
Code Code no. Art.Nr.	Descrizione Description Beschreibung	L= Lunghezza mm L= Length mm L= Länge mm
5.0011100	curvata / bended / vorgespannt	10000
5.0011137	curvata / bended / vorgespannt	13700

Guide / Beams / Dachgurtprofile "STANDARD LIGHT"

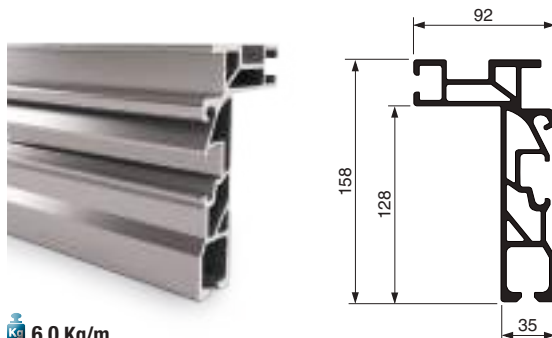
4,75 Kg/m

Code Code no. Art.Nr.	Descrizione Description Beschreibung	L= Lunghezza mm L= Length mm L= Länge mm
5.1022055	diritta / straight / gerade	5500
5.1022066	diritta / straight / gerade	6600
5.1022075	diritta / straight / gerade	7500
5.1022085	diritta / straight / gerade	8500
5.1021066	curvata / bended / vorgespannt	6600
5.1021075	curvata / bended / vorgespannt	7500
5.1021085	curvata / bended / vorgespannt	8500

Guide / Beams / Dachgurtprofile "SLIM LIGHT"

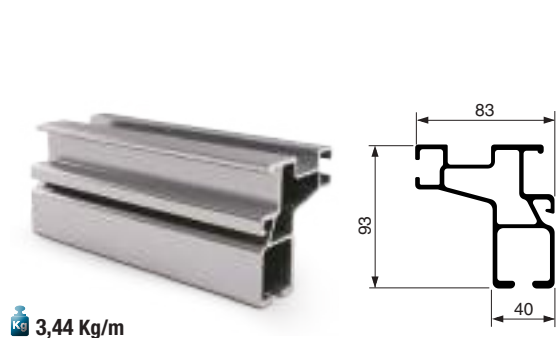
6,0 Kg/m

Code Code no. Art.Nr.	Descrizione Description Beschreibung	L= Lunghezza mm L= Length mm L= Länge mm
5.4032	diritta / straight / gerade	7500
5.4036	diritta / straight / gerade	8500
5.4268	diritta / straight / gerade	10000
5.4199	curvata / bended / vorgespannt	7500
5.4198	curvata / bended / vorgespannt	8500
5.4043	curvata / bended / vorgespannt	10000
5.4050	curvata / bended / vorgespannt	13700

Guide / Beams / Dachgurtprofile "SMALL"

3,44 Kg/m

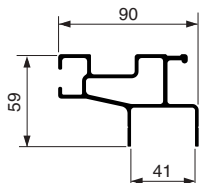
Code Code no. Art. Nr.	Descrizione Description Beschreibung	L= Lunghezza mm L= Length mm L= Länge mm
5.1011040	diritta / straight / gerade	4000
5.1011046	diritta / straight / gerade	4600
5.1011050	diritta / straight / gerade	5000

Guida / Beam / Dachgurtprofil "GENIUS"



2,0 Kg/m

Codice Code no. Art.Nr.	Descrizione Description Beschreibung	L= Lunghezza mm L= Length mm L= Länge mm
5.0711075	diritta / straight / gerade	7500

= Prodotto a Richiesta / Manufactured on Demand / auf Anfrage produziert

Profilo alluminio per mantovana guida GENIUS / Aluminium pelmet profile for GENIUS beam / Dichtlippenaluprofil für GENIUS Dachgurtprofil



0,74 Kg/m

Codice Code no. Art.Nr.	Descrizione Description Beschreibung	L= Lunghezza mm L= Length mm L= Länge mm
5.3360	diritta / straight / gerade	7500

= Prodotto a Richiesta / Manufactured on Demand / auf Anfrage produziert



Autocar
DISTRIBUTIONS